

Care and maintenance

Centor Integrated Doors



centor®

Keep your doors beautiful

Thank you for choosing a Centor Integrated Door for your home.

The world is beautiful and, at Centor, we believe in connecting people with the world outside by creating inside-outside living without the compromises. Not only are our products beautiful, they are engineered for all seasons, climates and times of day so you can enjoy the world around you both now and for years to come.

We want you to experience the joy of connecting with the beautiful world outside – be it a cool breeze on a lovely summer afternoon or a cosy winter night watching the snow fall outside. To maximise your inside-outside living experience, this guide will identify some important operation tips and maintenance requirements to ensure your doors continue to work beautifully and to keep your Centor Warranty valid.



Everyday use

Your Centor Integrated Door is designed to operate beautifully. However, inappropriate operation can cause serious damage that is not covered under warranty. Give your doors the care they deserve by operating them gently. If you notice they are not operating satisfactorily, contact your Centor Integrated Dealer immediately. In the meantime, refrain from using them until the issue can be resolved.

Be mindful of wind

Folding or swinging doors left unrestrained can be thrown about violently by sudden wind gusts – causing damage to the doors and nearby floors and walls. Always secure open doors, even on a calm day. All Centor Integrated Doors are supplied with magnetic holdback devices, but in some configurations these are left to the builder to determine the best installation method. These magnetic devices are designed to make everyday use a delight, however, they are not designed to withstand high wind loads. If strong wind is expected, close and secure the doors to prevent possible damage.

Shades are not designed to cope with wind. While we have gone to significant lengths to make the shades robust, a large shade is in effect a large sail and may be creased, torn or otherwise damaged by strong wind. Therefore, we recommend that your shades only be used when your doors are closed. If you do have a shade rolled out and wind is creating problems, you should first close the door panels before trying to roll the shades away. This will take the pressure off the fabric, allowing it to roll away easily and prevent potential damage.

Screens are designed to be used on an open doorway, but also being a large sail, strong wind gusts may cause problems. If it is windy, roll your screen away. Again, it may be necessary to close the doors first if you're experiencing strong wind gusts.

Be mindful of rain and moisture

Centor's integrated shades and screens are both made from fabrics that are resistant to water damage. However, shade fabrics in particular can be stained by water spreading dust or other contaminants unevenly across the surface of the fabric. Therefore, only use the shades while the doors are closed so that it does not get wet from rain. Localised wetting should be dabbed away immediately to minimise the risk of staining.

Be sure your shade or screen is dry before rolling it away. Rolling away a wet fabric slows down the drying process and can lead to mildew or mould growth. If they get wet, remove excess moisture and leave them out to dry.

If interior wood surfaces become wet, dry them as soon as possible using a paper towel or a soft cloth.

Locking and unlocking your doors

Access handle

Locking your door handle on the passage door is a two-step process whether you are inside or outside:

1. First, engage the auxiliary bolts by lifting the handle upwards. *Engaging the auxiliary bolts does not lock the door.*

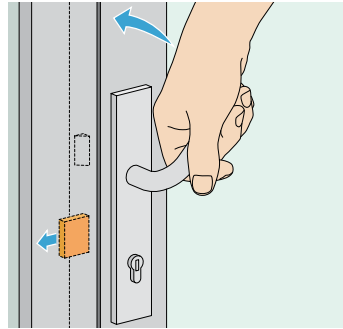
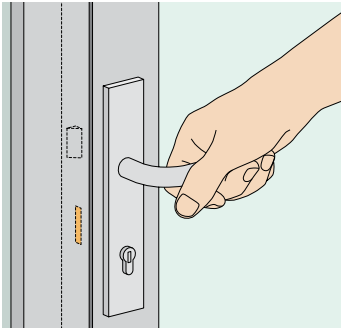

2. Lock the mechanism by rotating the key through 360°. (Note the key will only turn in one direction). When locked, the lever can no longer be operated from either inside or outside – check this by attempting to open the door.

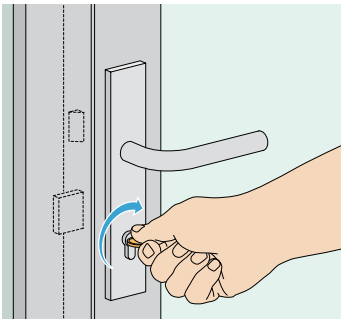

Unlocking the door handle is also a two-step process.

1. Rotate the key through 360° to unlock the mechanism.

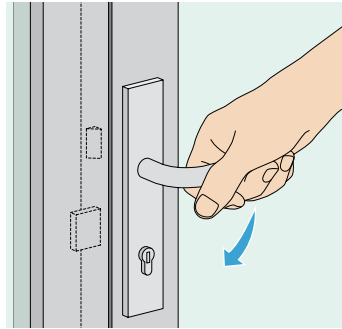
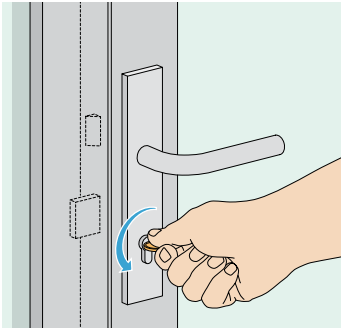

2. Unlock the door by pushing the handle downwards. This retracts the auxiliary bolts and also retracts the door latch.

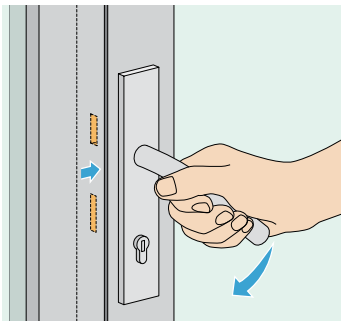

AutoLatch™

Folding door pairs and passive door panels are automatically locked when you close the door. Just pull the panel closed to engage the magnetic bolts in the head and sill. To unlock the AutoLatch™, just lift the concealed lever.

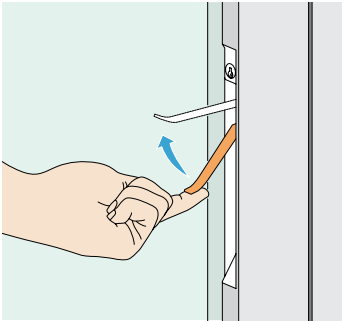

If you have a keyed AutoLatch™, then additionally you can key lock the doors. The key cylinder is concealed in the edge of the stile near the glass, and the locking operation is a 45° turn of the key which creates a distinct click, and when locked the lever can no longer be operated.

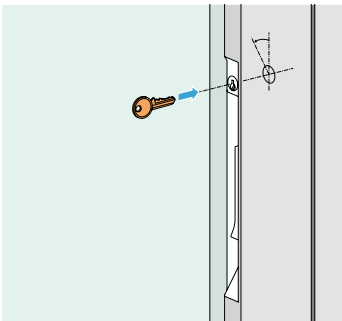



Using 3, 5 and 7-panel doors in one direction

Folding doors where three, five or seven panels operate from one side of the opening are a wonderful space saving solution, but it is important to be aware of the correct operating procedure for these configurations. Improper operation will cause the handle end of the leading door panel to drop when the doors are open, potentially damaging your doorsill or the adjacent floor.

Do:

1. Open the access panel fully and secure it back against the next panel before releasing the bifold panel pair(s).
2. Close the bifold pairs first, then finally close the access panel.



Gently push on the stacked panels while ensuring the access panel is folded flat against the nearest panel.



Close the next set of folding door pairs, using the recessed handle on the edge of the door to pull them closed.

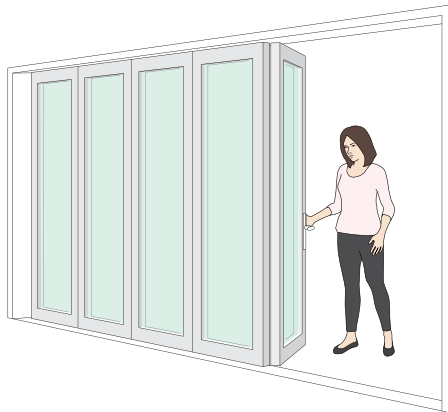

Finally, step outside and using the edge of the access panel, close the door behind you.

Do not:

1. Open all of the doors before securing the access panel against the panel next to it.
2. Close the doors by grabbing the door handle and pulling the access panel away from the open door stack.



If you use the access panel to pull the doors closed, the outside edge of the access panel could drag along the ground causing damage to both the floor and doors.



Cleaning

Frequency

These cleaning procedures need to be carried out according to the following schedule in order to maintain the validity of your Centor warranty:

- General environments 6 monthly
- Coastal & industrial environments* 3 monthly

*Coastal environments are defined as any residency within two kilometres of a body of salt water.

General

Vacuum floor channels regularly to remove debris. A build-up of sand, leaves or animal hair can affect the operation of your door, screen and/or shade.

Doorframe and glass – exterior

Choose a time when the door is out of strong, direct sunlight for cleaning. Strong sunlight may leave watermarks as water dries before you can wipe them away.

Recommended process:

1. First remove loose, dry contaminants from the surface of the door – (particularly sand and dirt from the sill area) using a soft brush and a vacuum cleaner, being careful not to scratch the paint by rubbing.
2. Gently hose down the door, to flush away as much surface contamination as possible. Do not use high pressure as this may force water inside your home, wetting interior wall and floor finishes.
3. Add a small amount of mild detergent (e.g. car wash or dishwashing liquid) to warm water. Always spot test your cleaning solution in an inconspicuous area before applying to the whole door.

Using a soft brush or a sponge, gently wash down the doorframe. Use water and a soft brush to clean debris away from corners and hardware at the sill area where dirt and other contaminants tend to collect. Finish by gently hosing the dirt away.

- Do not scrub surfaces as this can damage the paint finishes.
- Do not use solvents on painted surfaces.
- Do not use steel wool or coarse cloths.

4. Finally, move onto the glass. Wash the glass using plenty of warm water and mild detergent. It is important to use plenty of water and to rinse your sponge or mop regularly to avoid scratching the glass with the dust that has accumulated on the surface. This generous use of water also helps to remove salt build-up in coastal locations. Finish off by drying the glass using a Chamois cloth or a good quality squeegee to remove streaks and droplets.

In coastal locations, salt-spray may leave visible water marks on the glass that are difficult to remove. Try applying a 1:1 mix of water and white vinegar after the glass has already been cleaned. Do not leave the solution on for more than five minutes as vinegar is acidic, and therefore, corrosive. Wash the residue away by thoroughly flushing all surfaces of the door and surrounding floor finishes with plenty of clean water.

Using a blade to remove contaminants from the glass is likely to leave visible scratches. Call your Centor dealer for advice if you cannot wash contaminants away.

Doorframe and glass – interior

Recommended process:

1. Firstly, ensure your screens and shades have been properly rolled away and the interior floor around the door has some protection from water spillage.
2. Use a damp cloth for wiping down the frame and use a window cleaning mop or a soft cloth to wet and wash the glass. Keep a soft cloth on-hand to catch any water runoff.
3. Finally, use a Chamois cloth or a good quality squeegee to dry the glass. When using a squeegee on the inside, use a soft cloth or paper towel to collect water runoff immediately from the doorframe, floor and wall finishes.

Any scratches or chips in paint finishes on both the interior or exterior of the doorframes should be repaired immediately to avoid further deterioration and potential corrosion. Call your Centor dealer for advice on how to repair this damage.

Factory finished wood

The finish on wood surfaces will deteriorate with time and physical handling (e.g. around door handles), and is worsened in harsh environments.

It is important to monitor wood finishes and to reapply a compatible* finish before raw wood is exposed. Once exposed, stained finishes and deteriorated wood require a much more substantial restoration.

* Contact Centor for factory applied finishes or your builder for finishes applied on site.

Hardware and handles

Wipe with a mild detergent and a soft, damp cloth and allow to dry. Avoid abrasive cleaning solutions and cloths.

Screens

For a fast and easy clean, insect screen mesh can be vacuumed using a soft brush attachment.

For a more thorough clean, gently wipe down the insect mesh with a soft cloth dampened in water and a few drops of mild detergent.

Cleaning shades

Protect the fabric

Give your fabric the best chance to stay clean and beautiful for years to come.

- Roll it away when not serving a useful purpose.
- Clean contaminants and marks from the fabric as soon as possible.
- When cleaning the fabric, use the least invasive, simple procedures first, before progressing to a more aggressive approach.

Apply a protective coating of fluoro finish (e.g. Scotchguard) to fabrics that will be in high-use or dirty environments.

These coatings will also tend to eliminate static charge build-up, making dust and dirt less likely to adhere to the surface.

Before treating marks

1. Assess the nature of the contaminant material before trying to remove it. Some contaminants will only be made worse by trying to remove them. For example, a dry mark is best removed without water as wetting can spread the mark further into the material.
2. Always work in the least visible area first, and if applying any liquids, test first in an inconspicuous area of the fabric. Water marks can be left after cleaning with liquids if the fabric is not dried properly.
3. When cleaning marks, always work from the outside-in to avoid spreading the contaminated area.

Identify the source of the mark

1. Inspect the soiled area closely.
2. If you are sure you know what the contaminant is, then proceed to relevant treatment steps.
3. If unsure of what the contaminant is, trial cleaning steps very carefully, working through processes in this order:
 - Dry particulate matter (dust, dirt).
 - Grease and fingermarks.
 - Wine and plant juices.

Important notes for all cleaning processes

In all of the following processes, be sure to:

- Avoid working the contaminant into the fabric. Do not rub the mark.
- Work in a localised, inconspicuous area first.
- Avoid applying wetting agents to the fabric if possible – especially to the backing on blackout fabrics.
- Use cotton cloths for cleaning rather than synthetic materials (e.g. microfibre). Synthetic cloths tend to generate static charge in the fabric, which can make the contaminants adhere more aggressively.
- Avoid spreading the contaminant:
 - > Always work from outside in.
 - > When using a vacuum head, brush or cloth that will make contact with the fabric surface, ensure it's clean first.

- If any liquids are present, either as the contaminant or cleaning fluids, ensure that any dampness is sponged out as well as possible using a clean, dry cotton cloth.
 - > If practical, after sponging, force dry gently with a hair dryer (cool or warm air only) or similar, working from the centre of the damp area outwards to minimize possible water marks upon drying. Do not use hot air to dry.
 - > Leave the fabric to fully air dry before rolling the shade away.
- Centor recommends using deionized water wherever water is required for the cleaning process. Tap water carries salts and other contaminants that can leave stains. In addition, deionized water will tend to dissolve minerals and salts from contaminated sites on the fabric better than tap water. Deionized water from a new container is always more active than that from an old, part-used container.

Dry particulate matter (dust, dirt)

Dust and dirt can usually be successfully removed from the fabric and also from the backing of blackout fabric. The fabric is factory treated so that dust and dirt will not readily adhere to the fabric.

1. Vacuum the area without making direct contact with the fabric with the vacuum nozzle. This will require using a vacuum rod with a brush head attachment.
2. Use a clean brush to help dislodge adhered particles, working in one direction only and using the tip only of the brush to try to flick the particles off. Use in conjunction with a vacuum as in step 1.
3. Using a piece of clean cotton cloth, wipe in one direction only (do not scrub) from outside the mark towards the centre. Use a clean area of the cloth with each wipe. Apply the vacuum again as per step 1.
4. With a piece of adhesive tape, touch the adhesive surface lightly onto dirt marks and lift particles away from the surface. Repeat several times using a clean piece of tape, then try gently rubbing the back of the tape while the adhesive side is in contact with the marked surface.
5. Use a very lightly dampened cotton cloth, wipe in one direction only (do not scrub) working from outside the mark towards the centre. Use a clean area of the cloth with each wipe. If doing a large area, change or clean the cloth regularly.

Grease and fingermarks

Grease is a difficult contaminant to remove from the fabric as it gets locked between the fibres from where it is difficult to dislodge.

1. Prepare a 1:1 solution of white vinegar and warm (not cold), clean deionized water.
2. Spray the solution from an atomizing bottle or dab on the mark with a clean cotton cloth soaked in some of the vinegar solution.
Do not apply so much solution that runs occur; if they do, then sponge them up immediately with a dry cotton cloth. Do not rub the soiled area with the cloth as this may work the grease further into the fibres.
3. Immediately dampen another clean cloth in the solvent solution and gently sponge the soiled area to lift the dissolved grease away from the fabric. Note: solvents will dry fast, so ensure you have this mixture ready to go while the solvent is still wet.
4. Using a clean part of the dampened cloth, repeat the sponging process.
5. Repeat steps 1–4 above.
6. If repeated dabbing with the cloth dampened in the solvent solution does not work, then move to light wiping in one direction at a time, always working from outside to the centre of the mark.

Do not rub the backing on blackout fabric when using solvents of any kind.

If the vinegar solution fails to lift the stain, undiluted rubbing alcohol (e.g. denatured alcohol, methylated spirits) or similar solvents can be trialled in place of the vinegar following steps 1–6 above.

Wine and plant juices

Remove as much of the liquid as soon as possible with a dry cloth, avoiding spreading the stain further.

1. Dab lightly at the wet mark with a dry, clean cotton cloth, working from the outside-in.
2. Put a few drops of dishwashing liquid in a bowl of warm deionized water.
3. Lightly dampen a clean cotton cloth in the deionized water and detergent, then dab gently at the mark. Do not rub.
4. Repeat step 3. Be sure to use a clean area of the cloth each time to avoid re-contaminating the fabric.
5. Ensure that any dampness in the fabric is sponged out as well as possible using a clean, dry cotton cloth.
6. If practical, after sponging, force dry gently with a hair dryer or similar, working from the centre of the damp area outwards to minimise possible water marks. Do not use hot air to dry.
7. Leave the fabric to fully air dry before rolling the shade away.

If staining has occurred, it may be possible to remove or reduce the visibility of the stain by oxidizing it with hydrogen peroxide.

1. Prepare a diluted water/peroxide mix (maximum 3:2 of deionized water/peroxide). Be sure to add the peroxide to the water as per the directions on the peroxide bottle.
2. Using an atomizing spray bottle or a clean cotton cloth, carefully apply a small amount of the mixture to the stain.

3. After approximately 60 seconds, dab the liquid away with a paper towel or clean cotton cloth lightly dampened with deionized water and a few drops of dishwashing liquid.
4. Repeat application and dabbing process, increasing delay time progressively.
5. Do not allow the mixture to dry on the surface. Sponge dampness away with a dry, clean cotton cloth.
6. Leave the fabric to fully air dry before rolling the shade away.

Insects and Blood

Trapped insects can imprint on both sides of the fabric and effective removal will depend on the type of insect and the duration it has been left on the fabric.

1. Treat a dead insect or lizard as dry particulate matter, removing as much matter as possible without using liquid cleaners of any sort.
2. Wet blood stains should be dabbed away as soon as possible using a paper towel.
3. Treat any remaining contaminant as for wine and plant juices.



Adjustment

Buildings may move over time, causing the doors to become difficult to operate. Your Centor Integrated Door has a number of adjustments that can be made to compensate for this. Do not use force to overcome poor operation issues.

Please contact your builder or your Centor dealer for assistance if a problem arises.

Hardware maintenance

Spray a light coating of a high-quality lubricating and anti-corrosive solution such as, WD40 or Innox onto bearings and other working components. The use of a fine extension nozzle will help to reach concealed components and minimise overspray. Do not flood surfaces – they only need to be dampened by the liquid. Clean up any overspray or excess immediately using a soft cloth as it may affect paint finishes.

Areas to maintain:

1. Top and bottom pivots.

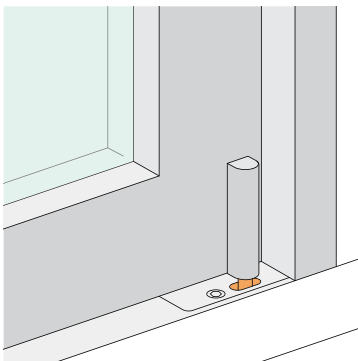
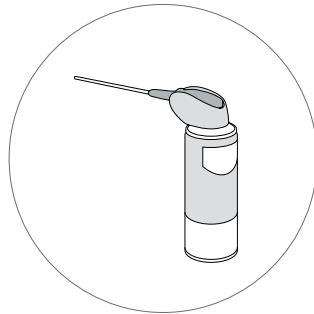
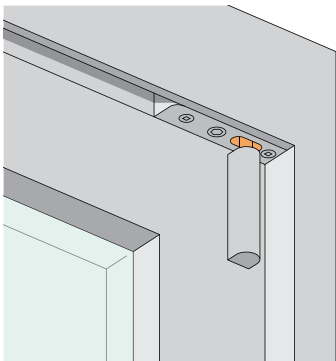

- 2. Bearings and hinges on door carriers and guides.

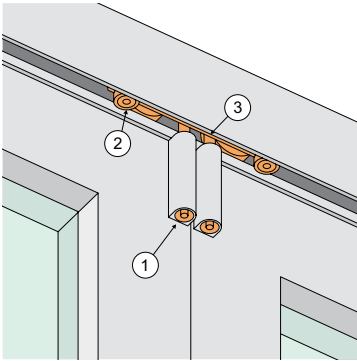

- 3. Concealed hinges.

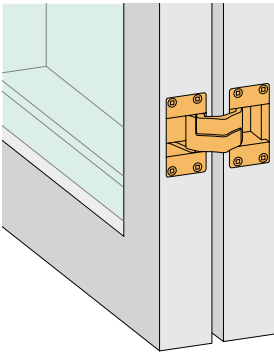

4. Bearings at the bottom of the screen and shade stiles and at the bottom of each jamb. Spray sparingly using an extension nozzle to avoid getting the liquid onto screen or shade fabrics.

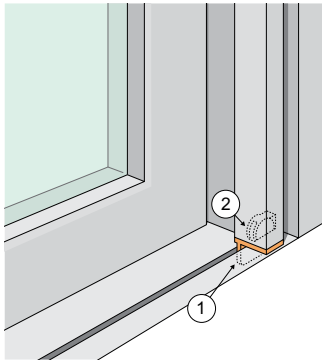

5. Autolatch™ bolts at the top and bottom of locking locations. These are located at the top and bottom of the panels which house the hidden handle.

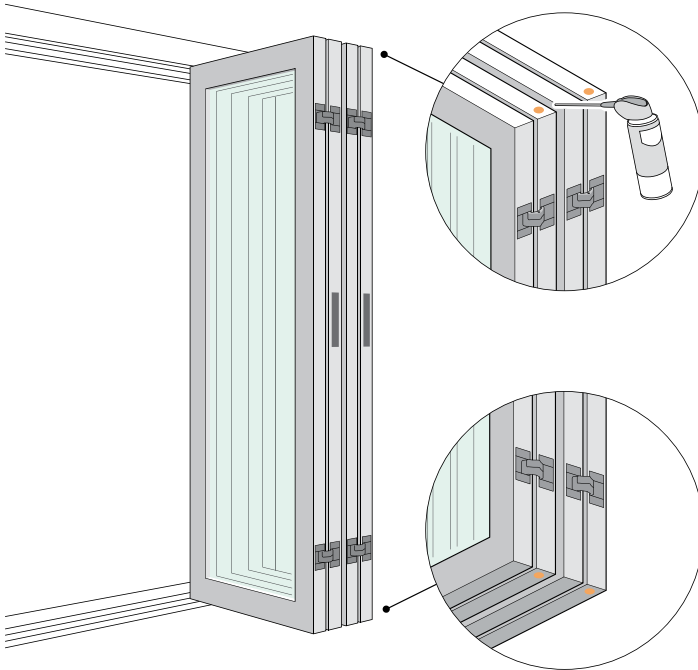

6. Door handles and key cylinders. Use a PTFE based dry lubricant spray. Teflon by DuPont® is one well-known trademark for PTFE. For key cylinders, use an extension nozzle, spray lightly into the keyway, then insert and remove the key 10 times to disperse the lubricant inside the cylinder before it dries.

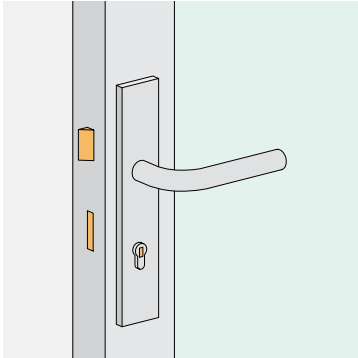

Glass condensation

Condensation occurs when warm, moist air comes into contact with a surface that is colder than the dew point of the air – just like a bathroom mirror will ‘steam up’ after a hot shower.

Modern, energy efficient building materials and techniques have resulted in higher relative humidity inside the home in cold weather because air transfer (or ventilation) has been virtually eliminated.

Glass is usually the first place you notice condensation for two reasons:

- Any condensation is highly visible as you look through the glass to the world outside.
- Glass is often one of the coldest surfaces in your home – even with the most energy efficient glass available.

So, if you see condensation on the glass in your doors, it is a natural process and not a product fault.

To control condensation inside your home, it will be necessary to reduce the relative humidity (RH) of the air. If you live in a cold climate, in winter you may need to reduce the RH below 30% to avoid condensation.



Your Centor dealer

Your doors have been supplied and installed by a Centor Integrated Dealer who is there to support you with any of your integrated Door queries. If a problem arises or you simply need advice on how to use or maintain your doors, please get in touch with your local dealer who will be delighted to help.



Centor Europe Ltd
Unit 6
Elmdon Trading Estate
Bickenhill Lane
Birmingham
B37 7HE, UK
t +44 (0)121 701 2500
mail.uk@centor.com
www.centor.com

centor®